

Operation Guide 3410

CASIO®

ENGLISH

Congratulations upon your selection of this CASIO watch.

Applications

The built-in sensors of this watch measure direction, barometric pressure, temperature and altitude. Measured values are then shown on the display. Such features make this watch useful when hiking, mountain climbing, or when engaging in other such outdoor activities.

Warning !

- The measurement functions built into this watch are not intended for taking measurements that require professional or industrial precision. Values produced by this watch should be considered as reasonable representations only.
- When engaging in mountain climbing or other activities in which losing your way can create a dangerous or life-threatening situation, always use a second compass to confirm direction readings.
- Note that CASIO COMPUTER CO., LTD. assumes no responsibility for any damage or loss suffered by you or any third party arising through the use of this product or its malfunction.

E-1

Important!

- Your watch's Altimeter Mode calculates relative altitude based on changes in barometric pressure measurement by its pressure sensor. For more information, see page E-36 and E-48.
- Immediately before embarking or otherwise taking altitude readings, be sure to specify a reference altitude. If you don't the readings produced by the watch probably will not be very accurate. For more information, see "To specify a reference altitude value" (page E-44).

About This Manual



- Depending on the model of your watch, digital display text appears either as dark figures on a light background, or light figures on a dark background. All examples in this manual are shown using dark figures on a light background.
- Button operations are indicated using the letters shown in the illustration.
- Note that the product illustrations in this manual are intended for reference only, and so the actual product may appear somewhat different than depicted by an illustration.

E-2

Things to check before using the watch

1. Check the battery power level.

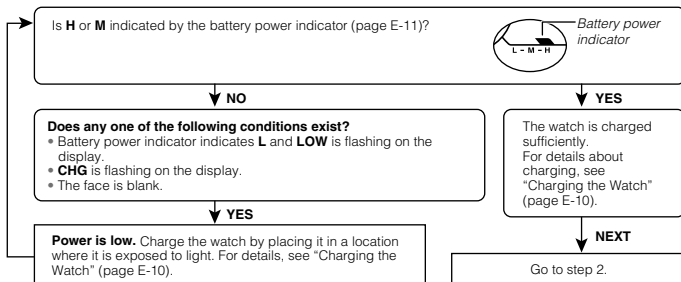

E-4

Contents

E-3	About This Manual
E-4	Things to check before using the watch
E-10	Charging the Watch
E-14	To recover from the sleep state
E-15	Radio Controlled Atomic Timekeeping
E-17	To get ready for a receive operation
E-19	To perform manual receive
E-22	To check the latest signal reception results
E-22	To turn auto receive on or off
E-24	Mode Reference Guide
E-29	Timekeeping
E-30	Using Date/Time Records
E-31	Configuring Home City Settings
E-31	To configure Home City and summer time settings
E-33	Configuring Current Time and Date Settings Manually
E-33	To change the current time and date settings manually
E-35	Specifying Temperature, Barometric Pressure, and Altitude Display Units
E-35	To specify temperature, barometric pressure, and altitude display units

E-6

2. Check the Home City and the daylight saving time (DST) setting.

Use the procedure under "To configure Home City and summer time settings" (page E-31) to configure your Home City and daylight saving time settings.

Important!

Proper time calibration signal reception, and World Time Mode and Sunrise/Sunset Mode data depend on correct Home City, time, and date settings in the Timekeeping Mode. Make sure you configure these settings correctly.

3. Set the current time.

- To set the time using a time calibration signal
See "To get ready for a receive operation" (page E-17).
- To set the time manually
See "Configuring Current Time and Date Settings Manually" (page E-33).

The watch is now ready for use.

- For details about the watch's radio controlled timekeeping feature, see "Radio Controlled Atomic Timekeeping" (page E-15).

E-3

E-5

E-36 Using the Altimeter Mode

- E-37 To select the altitude screen format
- E-37 To select the altitude auto reading interval
- E-39 To take altitude readings
- E-42 To specify the altitude differential start point
- E-43 To use the altitude differential value
- E-44 To specify a reference altitude value
- E-45 To save a reading manually

E-51 Precautions Concerning Simultaneous Altitude and Temperature Readings

E-52 Taking Direction Readings

- E-52 To perform 2-point calibration
- E-54 To take a direction reading
- E-58 To perform magnetic declination correction

E-61 Taking Barometric Pressure and Temperature Readings

- E-61 To take barometric pressure and temperature readings
- E-66 To enable or disable the barometric pressure change alert
- E-68 To calibrate the pressure sensor and the temperature sensor

E-70 Viewing Memory Records

- E-70 To view data in watch memory
- E-74 To delete all saved data
- E-74 To delete a specific record

E-7

E-75 Checking the Current Time in a Different Time Zone

- E-75 To enter the World Time Mode
- E-75 To view the time in another time zone
- E-76 To specify standard time or daylight saving time (DST) for a city

E-77 Using the Stopwatch

- E-77 To enter the Stopwatch Mode
- E-77 To perform an elapsed time operation
- E-77 To pause at a split time
- E-78 To measure two finishes

E-79 Using the Countdown Timer

- E-79 To enter the Countdown Timer Mode
- E-79 To specify the countdown start time
- E-80 To perform a countdown timer operation
- E-80 To stop the alarm

E-81 Using the Alarm

- E-81 To enter the Alarm Mode
- E-82 To set an alarm time
- E-83 To turn an alarm and the Hourly Time Signal on and off
- E-83 To stop the alarm

E-84 Looking up Sunrise and Sunset Times

- E-84 To view sunrise and sunset times
- E-85 To view the sunrise/sunset time for a particular date
- E-86 To look up the sunrise and sunset times for a specific location

E-88 Illumination

- E-88 To turn on illumination manually
- E-88 To change the illumination duration
- E-90 To turn the auto light switch on and off

E-92 Other Settings

- E-92 To turn the button operation tone on and off
- E-93 To turn Power Saving on or off

E-94 Troubleshooting

E-100 Specifications

E-8

E-9

Charging the Watch

The face of the watch is a solar panel that generates power from light. The generated power charges a built-in rechargeable battery, which powers watch operations. The watch charges whenever it is exposed to light.

Charging Guide



Whenever you are not wearing the watch, leave it in a location where it is exposed to light.

- Best charging performance is achieved by exposing the watch to the strongest light available.

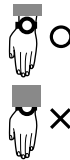

When wearing the watch, make sure that its face is not blocked from light by the sleeve of your clothing.

- The watch may enter a sleep state (page E-14) if its face is blocked by your sleeve even only partially.

Warning!

Leaving the watch in bright light for charging can cause it to become quite hot. Take care when handling the watch to avoid burn injury. The watch can become particularly hot when exposed to the following conditions for long periods.

- On the dashboard of a car parked in direct sunlight
- Too close to an incandescent lamp
- Under direct sunlight

E-10

E-11

Level	Battery Power Indicator	Function Status
3 (L)		Auto and manual receive, illumination, beeper, and sensor operation disabled.
4 (CHG)		Except for the CHG (charge) indicator, all functions and display indicators disabled.
5	---	All functions disabled.

- The flashing **LOW** indicator at Level 3 (L) tells you that battery power is very low, and that exposure to bright light for charging is required as soon as possible.
- Display indicators reappear as soon as the battery is charged from Level 5 to Level 2 (M).
- Leaving the watch exposed to direct sunlight or some other very strong light source can cause the battery power indicator to show a reading temporarily that is higher than the actual battery level. The correct battery level should be indicated after a few minutes.

E-12

*1 Approximate amount of exposure time required each day to generate enough power for normal daily operation.

*2 Approximate amount of exposure time (in hours) required to take power from one level to the next.

- The above exposure times all are for reference only. Actual exposure times depend on lighting conditions.
- For details about the operating time and daily operating conditions, see the "Power Supply" section of the Specifications (page E-103).

Power Saving

When turned on, Power Saving enters a sleep state automatically whenever the watch is left for a certain period in an area where it is dark. The table below shows how watch functions are affected by Power Saving.

- For information about enabling and disabling power saving, see "To turn Power Saving on or off" (page E-93).
- There actually are two sleep state levels: "display sleep" and "function sleep".

Elapsed Time in Dark	Display	Operation
60 to 70 minutes (display sleep)	Blank, with PS flashing	Display is off, but all functions are enabled.
6 or 7 days (function sleep)	Blank, with PS not flashing	All functions are disabled, but timekeeping is maintained.

- The watch will not enter a sleep state between 6:00 AM and 9:59 PM. If the watch is already in a sleep state when 6:00 AM arrives, however, it will remain in the sleep state.
- Power Saving is enabled only when the watch is in the Timekeeping Mode with the Day of the Week screen displayed (page E-29) or in the World Time Mode (page E-75).

To recover from the sleep state

Move the watch to a well-lit area, press any button, or angle the watch towards your face for reading (page E-89).

E-14

Important!

- Allowing the watch to become very hot can cause its liquid crystal display to black out. The appearance of the LCD should become normal again when the watch returns to a lower temperature.
- Turn on the watch's Power Saving function (page E-14) and keep it in an area normally exposed to bright light when storing it for long periods. This helps to ensure that power does not run down.
- Storing the watch for long periods in an area where there is no light or wearing it in such a way that it is blocked from exposure to light can cause power to run down. Expose the watch to bright light whenever possible.

Power Levels

You can get an idea of the watch's power level by observing the battery power indicator on the display.

Important!

- If low battery power is indicated, expose the face of the watch to direct light to charge. At Level 5, the battery is dead, which causes watch functions to stop, all data in watch memory to be deleted, and all watch settings to return to their initial factory defaults.

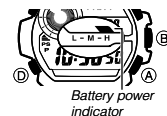

Level	Battery Power Indicator	Function Status
1 (H)		All functions enabled.
2 (M)		All functions enabled.

Power Recovery Mode

- Performing multiple sensor, illumination, or beeper operations during a short period may cause all of the battery power indicators (H, M, and L) to start flashing on the display. This indicates that the watch is in the power recovery mode. Illumination, alarm, countdown timer alarm, hourly time signal, and sensor operations will be disabled until battery power recovers.
- Battery power will recover in about 15 minutes. At this time, the battery power indicators (H, M, L) will stop flashing. This indicates that the functions listed above are enabled again.
- If all of the battery power indicators (H, M, L) are flashing and the **CHG** (charge) indicator also is flashing, it means the battery level is very low. Expose the watch to bright light as soon as possible.
- Even if battery power is at Level 1 (H) or Level 2 (M), the Digital Compass Mode, Barometer/Thermometer Mode, or Altimeter Mode sensor may be disabled if there is not enough voltage available to power it sufficiently. This is indicated when all of the battery power indicators (H, M, L) are flashing.
- Frequent flashing of all of the battery power indicators (H, M, L) probably means that remaining battery power is low. Leave the watch in bright light to allow it to charge.

Charging Times

Exposure Level (Brightness)	Daily Operation *1	Level Change *2				
		Level 5	Level 4	Level 3	Level 2	Level 1
Outdoor sunlight (50,000 lux)	5 min.	→		→	→	→
Sunlight through a window (10,000 lux)	24 min.	→		→	→	→
Daylight through a window on a cloudy day (5,000 lux)	48 min.	→		→	→	→
Indoor fluorescent lighting (500 lux)	8 hours	→		→	→	→

E-13

Radio Controlled Atomic Timekeeping

This watch receives a time calibration signal and updates its time setting accordingly. However, when using the watch outside of areas covered by time calibration signals, you will have to adjust the settings manually as required. See "Configuring Current Time and Date Settings Manually" (page E-33) for more information.

This section explains how the watch updates its time settings when the city code selected as the Home City is in Japan, North America, Europe, or China, and is one that supports time calibration signal reception.

If your Home City Code setting is this:	The watch can receive the signal from the transmitter located here:
LIS, LON, MAD, PAR, ROM, BER, STO, ATH, MOW	Anthon (England), Mainflingen (Germany)
HKG, BJS	Shangqiu City (China)
TPE, SEL, TYO	Fukushima (Japan), Fukuoka/Saga (Japan)
HNL, ANC, YVR, LAX, YEA, DEN, MEX, CHI, NYC, YHZ, YYT	Fort Collins, Colorado (United States)

Important!

- The areas covered by **MOW**, **HNL** and **ANC** are quite far from the calibration signal transmitters, so certain conditions may cause reception problems.
- When **HKG** or **BJS** is selected as the Home City, only the time and date are adjusted according to the time calibration signal. You need to switch manually between standard time and daylight saving time (DST) if required. See "To configure Home City and summer time settings" (page E-31) for information about how to do this.

E-15

Approximate Reception Ranges

UK and German Signals

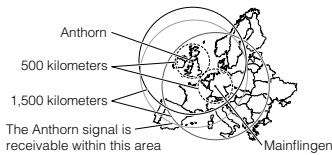

North American Signal

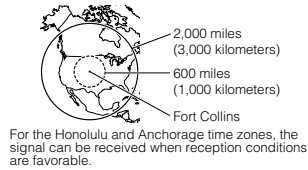

Japanese Signals

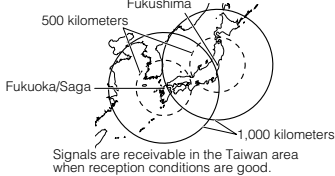

Chinese Signal

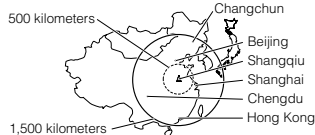

- Even when the watch is within range of a transmitter, signal reception may be impossible due to the effects of geographic contours, structures, weather, the time of year, the time of day, radio interference, etc. The signal becomes weaker at distances of approximately 500 kilometers, which means that the influence of the conditions listed above becomes even greater.
- Signal reception may not be possible at the distances noted below during certain times of the year or day. Radio interference may also cause problems with reception.
- Mainflingen (Germany) or Anthon (England) transmitters: 500 kilometers (310 miles)
- Fort Collins (United States) transmitter: 600 miles (1,000 kilometers)
- Fukushima or Fukuoka/Saga (Japan) transmitters: 500 kilometers (310 miles)
- Shanglei (China) transmitter: 500 kilometers (310 miles)
- As of December 2012, China does not use Daylight Saving Time (DST). If China does go to the Daylight Saving Time system in the future, some functions of this watch may no longer operate correctly.

To get ready for a receive operation

1. Confirm that the watch is in the Timekeeping Mode or World Time Mode. If it isn't, use **(D)** to enter the Timekeeping Mode or World Time Mode (page E-26).
2. The antenna of this watch is located on its 12 o'clock side. Position the watch with 12 o'clock facing towards a window as shown in the nearby illustration. Make sure there are no metal objects nearby.

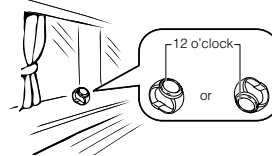

E-16

E-17

- Signal reception may be difficult or even impossible under the conditions described below.

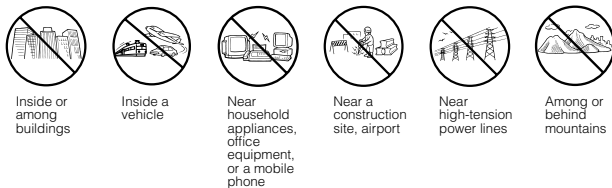

3. What you should do next depends on whether you are using auto receive or manual receive.

- Auto receive: Leave the watch over night in the location you selected in step 2. See "Auto Receive" below for details.
- Manual receive: Perform the operation under "To perform manual receive" on page E-19.

Auto Receive

- With auto receive, the watch performs the receive operation each day automatically up to six times (up to five times for the Chinese calibration signal) between the hours of midnight and 5 a.m. (according to the Timekeeping Mode time). When any receive operation is successful, none of the other receive operations for that day are performed.
- When a calibration time is reached, the watch will perform the receive operation only if it is in the Timekeeping Mode or World Time Mode. The receive operation is not performed if a calibration time is reached while you are configuring settings.

E-18

- You can use the procedure under "To turn auto receive on and off" (page E-22) to enable or disable auto receive.

To perform manual receive

1. Use **(D)** to select the Receive Mode (R/C) as shown on page E-26.
2. Hold down **(A)** until **RC Hold** appears on the display and then disappears.

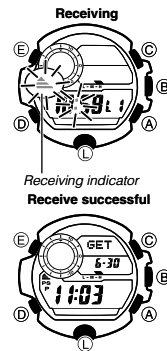

- A signal level indicator (**L1**, **L2**, or **L3**; see page E-21) will appear on the display after reception starts. Do not allow the watch to move and do not perform any button operation until **GET** or **ERR** appears on the display.
- If the receive operation is successful, the reception date and time appear on the display, along with the **GET** indicator. The watch will return to the Timekeeping Mode if you press **(D)** or if you do not perform any button operation for about two or three minutes.

E-19

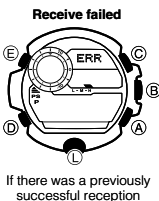

- If the current reception fails but a previous reception (within the last 24 hours) was successful, the display shows the receiving indicator and the **ERR** indicator. If the **ERR** indicator only is displayed (without the receiving indicator), it means that all of the receive operations over the past 24 hours have failed. The watch will return to the Timekeeping Mode without changing the time setting if you press **(D)** or if you do not perform any button operation for about two or three minutes.

Note

- You can interrupt a time calibration signal reception operation by pressing any button.

If there was a previously successful reception

Signal Level Indicator

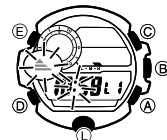

During manual receive, the signal level indicator displays the signal level as shown below.



The level indication will change in accordance with reception conditions while reception is being performed. As you watch the indicator, keep the watch in a location that best maintains stable reception.

- Even under optimum reception conditions, it can take about 10 seconds for reception to stabilize.
- Note that weather, the time of day, surroundings, and other factors all can affect reception.

E-20

E-21

To check the latest signal reception results



1. Enter the Receive Mode (page E-26).
2. When receive is successful, the display shows the time and date that receive was successful. **-:--** indicates that none of the reception operations were successful.
3. To return to the Timekeeping Mode, press **(D)**.

Note

- Note that the setting screen will not appear if the currently selected Home City is one that does not support time calibration reception.

To turn auto receive on or off

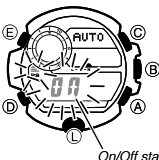

1. Enter the Receive Mode (page E-26).
2. Hold down **(E)** for at least two seconds. Release **(E)** after **AUTO** appears. This is the setting screen.
 - Note that the setting screen will not appear if the currently selected Home City is one that does not support time calibration reception.
3. Press **(A)** to toggle auto receive between on (**On**) and off (**OFF**).
4. Press **(E)** to exit the setting screen.

Radio-controlled Atomic Timekeeping Precautions

- Strong electrostatic charge can result in the wrong time setting.
- Even if a receive operation is successful, certain conditions can cause the time setting to be off by up to one second.
- The watch is designed to update the date and day of the week automatically for the period January 1, 2000 to December 31, 2099. Updating of the date by signal reception will no longer be performed starting from January 1, 2100.
- If you are in an area where signal reception is not possible, the watch keeps time with the precision noted in "Specifications".
- The receive operation is disabled under any of the following conditions.
 - While power is at Level 3 (L) or lower (page E-11)
 - While the watch is in the power recovery mode (page E-13)
 - While a direction, barometric pressure/temperature, or altitude reading operation is in progress
 - When the watch is in the function sleep state ("Power Saving", page E-14)
 - While the barometric pressure change indicator is displayed
 - While a countdown timer operation is in progress (page E-79)
- A receive operation is cancelled if an alarm sounds while it is being performed.
- The Home City setting reverts to the initial default of **TYO** (Tokyo) whenever the battery power level drops to Level 5 or when you have the rechargeable battery replaced. If this happens, change the Home City to the setting you want (page E-31).

E-22

E-23

Mode Reference Guide

Your watch has 11 "modes". The mode you should select depends on what you want to do.

To do this:	Enter this mode:	See:
<ul style="list-style-type: none"> View the current date in the Home City Configure Home City and daylight saving time (DST) settings Configure time and date settings manually Record the current date and time 	Timekeeping Mode	E-29
<ul style="list-style-type: none"> View the altitude at your current location Determine the altitude differential between two locations (reference point and current location) Record the current altitude reading along with the reading date and time 	Altimeter Mode	E-36
<ul style="list-style-type: none"> Determine your current bearing or the direction from your current location to a destination Record the current direction reading along with the reading date and time 	Digital Compass Mode	E-52
<ul style="list-style-type: none"> View the barometric pressure and temperature at your current location View a graph of barometric pressure readings View barometric pressure tendency information Record the current barometric pressure and readings along with the reading date and time 	Barometer/Thermometer Mode	E-61
View the current time in one of 48 cities (31 time zones) around the globe	World Time Mode	E-75
Use the stopwatch to measure elapsed time	Stopwatch Mode	E-77
Use the countdown timer	Countdown Timer Mode	E-79
Set an alarm time	Alarm Mode	E-81

E-24

E-25

Selecting a Mode

- The illustration below shows which buttons you need to press to navigate between modes.
- To return to the Timekeeping Mode from any other mode, hold down **(D)** for about two seconds.
- In the Timekeeping Mode, press **(A)** to enter the Stopwatch Mode (page E-77).

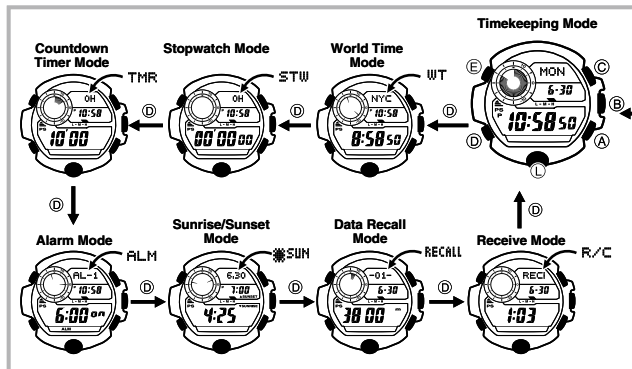

E-26

- This watch has three "sensor modes": Altimeter Mode, Digital Compass Mode, and Barometer/Thermometer Mode. Press the **(B)** button to display a sensor mode screen.
- The sensor mode that was displayed when you last returned to the Timekeeping Mode will appear first.

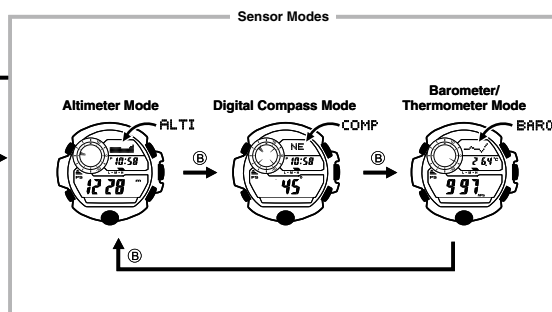

E-27

General Functions (All Modes)

The functions and operations described in this section can be used in all of the modes.

Auto Return Features

- The watch will automatically return to the Timekeeping Mode if you do not perform any button operation for a particular amount of time in each mode.

Mode Name	Approximate Elapsed Time
Sunrise/Sunset, Data Recall, Alarm, Receive, Digital Compass	3 minutes
Altimeter	1 hour minimum 12 hours maximum
Barometer/Thermometer	1 hour
Setting screen (digital setting flashing)	3 minutes

- If you leave a screen with flashing digits on the display for two or three minutes without performing any operation, the watch exits the setting screen automatically.

Initial Screens

When you enter the Data Recall, Alarm, World Time, or Digital Compass Mode, the data you were viewing when you last exited the mode appears first.

Scrolling

The **(A)** and **(C)** buttons are used on the setting screen to scroll through data on the display. In most cases, holding down these buttons during a scroll operation scrolls through the data at high speed.

E-28

Timekeeping

Use the Timekeeping Mode (TIME) to set and view the current time and date.

- Each press of **(E)** in the Timekeeping Mode will change screen contents as shown below.

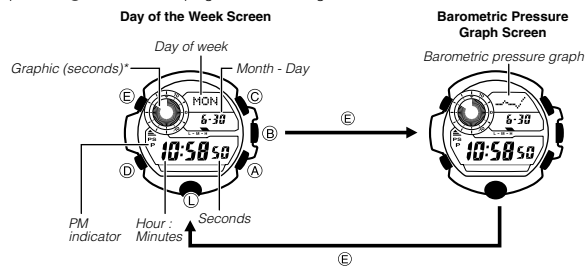

* The graphic appears as the pattern shown below when a stopwatch elapsed time operation is in progress or paused (page E-77).



C

E-29

Using Date/Time Records

You can use the procedure in this section to create a date/time record of the current date (month, day, year) and time (minute second). You can later recall a record to view it.

Important!

- The watch has memory for storage of up to 40 records of various types. If you perform an operation that creates a new record while there are already 40 records in memory, the oldest record is deleted automatically to make room for the new one (page E-70).

- In the Timekeeping Mode, hold down **(C)** until the watch beeps (about 0.5 seconds).
 - REC** will appear on the display, indicating that a record of the current date and time was created. After about one second, the watch will return to the Timekeeping Mode screen.
- To view a record, enter the Data Recall Mode (page E-26) and use the **(A)** and **(C)** buttons to scroll. See "Viewing Memory Records" (page E-70) for more information.

E-30

Configuring Home City Settings

There are two Home City settings: actually selecting the Home City and selecting either standard time or daylight saving time (DST).

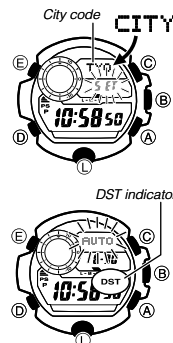

To configure Home City and summer time settings

- In the Timekeeping Mode, hold down **(E)** for at least two seconds. **SET** and **Hold** will appear on the display first, and then **Hold** will disappear. Release **(E)** after **Hold** disappears.
 - The watch will exit the setting mode automatically if you do not perform any operation for about two or three minutes.
 - For details about city codes, see the "City Code Table" at the back of this manual.
- Use **(A)** (East) and **(C)** (West) to scroll through the available city codes.
 - Keep scrolling until the city code you want to select as your Home City is displayed.
- Press **(D)** to display the DST setting screen.
- Use **(A)** to cycle through the DST settings in the sequence shown below.

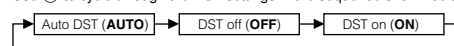

E-31

- The Auto DST (**AUTO**) setting will be available only when a city code that supports time calibration signal reception (page E-15) is selected as the Home City. While Auto DST is selected the DST setting will be changed automatically in accordance with time calibration signal data.
- Note that you cannot switch between standard time and daylight saving time (DST) while UTC is selected as your Home City.

5. After all of the settings are the way you want, press **(E)** twice to exit the setting screen.
- Daylight Saving Time is turned on when the **DST** indicator is on the display.

Note

- After you specify a city code, the watch will use UTC* offsets in the World Time Mode to calculate the current time for other time zones based on the current time in your Home City.
 - * Coordinated Universal Time, the world-wide scientific standard of timekeeping. The reference point for UTC is Greenwich, England.
- Selecting some city codes automatically makes it possible for the watch to receive the time calibration signal for the corresponding area. See page E-15 for details.

Configuring Current Time and Date Settings Manually

You can configure current time and date settings manually when the watch is unable to receive a time calibration signal.

Important!

- Before configuring current time and date settings, be sure set your Home City (page E-31).

To change the current time and date settings manually

- In the Timekeeping Mode, hold down **(E)** for at least two seconds. **SET** and **Hold** will appear on the display first, and then **Hold** will disappear. Release **(E)** after **Hold** disappears.
- Press **(D)** to move the flashing in the sequence shown below to select the other settings.

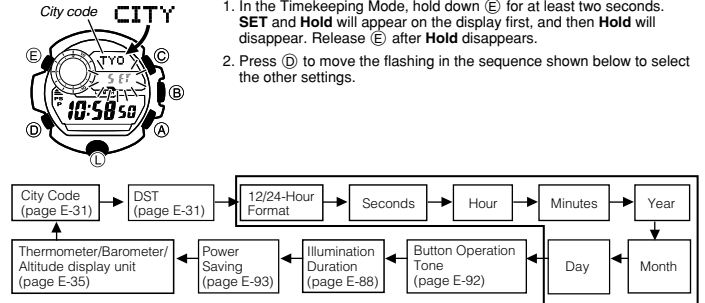

3. When the timekeeping setting you want to change is flashing, use **(A)** and/or **(C)** to change it as described below.

Screen	To do this:	Do this:
12H	Toggle between 12-hour (12H) and 24-hour (24H) timekeeping.	Press (A) .
58	Reset the seconds to 00 (If the current seconds count is between 30 and 59, one is added to the minute count).	Press (A) .
10:58	Change the hour or minutes	Use (A) (+) and (C) (-).
2013 6-30	Change the year, month, or day	

4. After all of the settings are the way you want, press **(E)** twice to exit the setting screen.

Note

- While the 12-hour format is selected for timekeeping, a **P** (PM) indicator will appear for times from noon to 11:59 p.m. No indicator appears for times from midnight to 11:59 a.m. With 24-hour format, time is displayed from 0:00 to 23:59, without any **P** (PM) indicator.
- The watch's built-in full automatic calendar makes allowances for different month lengths and leap years. Once you set the date, there should be no reason to change it except after you have the watch's rechargeable battery replaced or after power drops to Level 5 (page E-11).
- The day of the week changes automatically when the date changes.

Specifying Temperature, Barometric Pressure, and Altitude Display Units

Use the procedure below to specify the temperature, barometric pressure, and altitude display units to be used in the Barometer/Thermometer Mode and the Altimeter Mode.

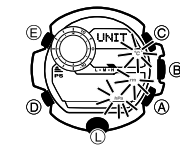

Important!

- When **TYO** (Tokyo) is selected as the Home City, the altitude unit is set automatically to meters (**m**), the barometric pressure unit to hectopascals (**hPa**), and the temperature unit to Celsius (**°C**). These settings cannot be changed.

To specify temperature, barometric pressure, and altitude display units

- In the Timekeeping Mode, hold down **(E)** for at least two seconds. **SET** and **Hold** will appear on the display first, and then **Hold** will disappear. Release **(E)** after **Hold** disappears.

- Press **(D)** as many times as necessary until **UNIT** appears on the display (page E-33).
- Perform the operations below to specify the display units you want.

To specify this unit:	Press this key:	To toggle between these settings:
Altitude	(A)	m (meters) and ft (feet)
Barometric Pressure	(B)	hPa (hectopascals) and inHg (inches of mercury)
Temperature	(C)	°C (Celsius) and °F (Fahrenheit)

4. After all of the settings are the way you want, press **(E)** twice to exit the setting screen.

Using the Altimeter Mode

The watch takes altitude readings and displays results based on air pressure measurements taken by a built-in pressure sensor. It also saves various types of altitude records and data.

Getting Ready

Before actually taking an altitude reading you need to select an altitude screen format and select an altitude reading interval.

Selecting the Altitude Screen Format

You can select either of two screen formats for the Altimeter Mode.

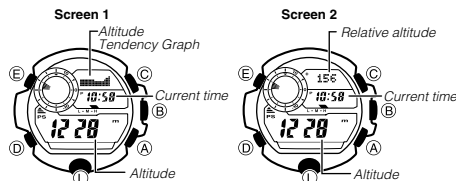

- Altitude tendency graph contents are updated each time you take an altitude reading.
- To take readings of the difference between the altitude at your current location and the altitude at a reference point, select Screen 2. See "Using an Altitude Differential Value" (page E-42) for more information.

Taking Altitude Readings

Use the procedure below to take basic altitude readings.

- See "Using Reference Altitude Values" (page E-44) for information about how to make altimeter readings more accurate.
- See "How does the altimeter work?" (page E-48) for information about how the watch measures altitude.

To take altitude readings

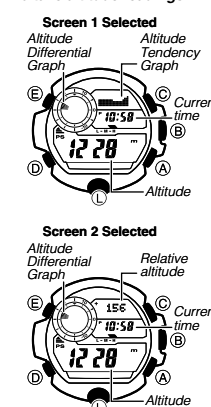

- Enter the Altimeter Mode (page E-27).
- This will automatically start an altitude reading operation, and the result will appear on the display as a value in 1-meter (5-foot) units.
 - Readings will continue to be taken about every second for the first three minutes. For information about the reading interval after that, see page E-37.
 - You can restart the reading operation from the beginning at any time by pressing **(C)**.

Note

- After you are finished, press **(D)** to return to the Timekeeping Mode and stop auto altimeter readings.
- The watch will return to the Timekeeping Mode automatically if you do not perform any operation (page E-28).
- The measurement range for altitude is -700 to 10,000 meters (-2,300 to 32,800 feet).
- The displayed altitude value changes to - - - if an altitude reading falls outside the measurement range. An altitude value will reappear as soon as the altitude reading is within the allowable range.
- Normally, displayed altitude values are based on the watch's preset conversion values. You also can specify a reference altitude value, if you want. See "Using Reference Altitude Values" (page E-44).
- You can change the unit for displayed altitude values to either meters (**m**) or feet (**ft**). See "To specify temperature, barometric pressure, and altitude display units" (page E-35).

Checking the Latest Changes in Altitude

- The altitude differential graph shows the difference between the currently displayed altitude reading and the previous reading during while readings are being taken automatically.

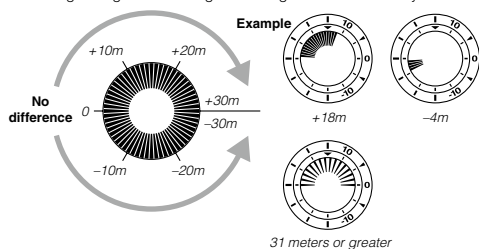

- The altitude tendency graph shows changes in altitude over the past 20 readings while readings are being taken automatically.

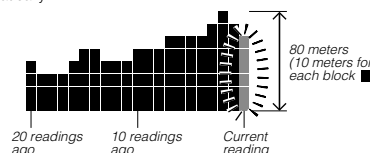

Advanced Altimeter Mode Operations

Use the information in this section to obtain more accurate altimeter readings, especially while mountain climbing or trekking.

E-40

E-41

Using an Altitude Differential Value



The Altimeter Mode screen has an altitude differential value that shows the change in altitude from a reference point you specify. The altitude differential value is updated each time the watch takes an altitude reading.

- The range of the altitude differential value is -9,995 feet to 3,000 meters (9,995 feet).
- is displayed in place of the altitude differential value whenever the measured value is outside the allowable range.
- See "Using the Altitude Differential Value While Mountain Climbing or Hiking" (page E-43) for some real-life examples of how to use this feature.

To specify the altitude differential start point



- In the Altimeter Mode, select Screen 2 as the Altimeter Mode display (page E-37).
- Press (A).
 - The watch will take an altitude reading and register the result as the altitude differential value start point. The altitude differential value will be reset to zero at this time.

Using the Altitude Differential Value While Mountain Climbing or Hiking

After you specify the altitude differential start point while mountain climbing or hiking, you can easily measure the change in the altitude between that point and other points along the way.

To use the altitude differential value

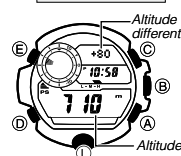
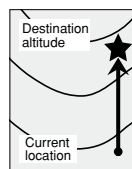

- In the Altimeter Mode, check to make sure that an altitude reading is on the display.
 - If an altitude reading is not displayed, press (C) to take one. See "To take altitude readings" (page E-39) for details.
- Use the contour lines on your map to determine the difference in altitude between your current location and your destination.
- In the Altimeter Mode, press (A) to specify your current location as the altitude differential start point.
 - The watch will take an altitude reading and register the result as the altitude differential value start point. The altitude differential value will be reset to zero at this time.
- While comparing the altitude difference you determined on the map and the watch's altitude differential value, advance towards your destination.
 - If the map shows that the difference in altitude between your location and your destination is +80 meters for example, you know you will be nearing your destination when the displayed altitude differential value shows +80 meters.

E-42

E-43

Using Reference Altitude Values

To minimize the chance of reading error, you should update the reference altitude value before setting off on a trek or any other activity where you plan to take altitude readings. During a trek, keep checking the readings produced by the watch against altitude information provided by markers and other information, and update the reference altitude value as required.

- Reading error can be caused by changes in barometric pressure, atmospheric conditions, and elevation.
- Before performing the procedure below, look up the altitude of your current location on a map, the Internet, etc.

To specify a reference altitude value

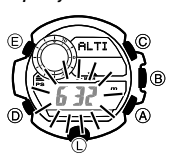

- In the Altimeter Mode, hold down (E) for at least two seconds. You can release (E) after ALTI appears.
 - The current altitude reading value will appear at this time.
- Use (A) (+) or (C) (-) to change the current reference altitude value in 1-meter (5-foot) increments.
 - Change the reference altitude value to an accurate altitude reading that you get from a map or other source.
 - You can set the reference altitude value within the range of -10,000 to 10,000 meters (-32,800 to 32,800 feet).
 - Pressing (A) and (C) at the same time returns to OFF (no reference altitude value), so the watch performs air pressure to altitude conversions based on preset data only.
- Press (E) to exit the setting screen.

Types of Altitude Data

Your watch stores two types of altitude data: altitude records and historical altitude values.

Manually Saved Records

Each altitude reading you take manually is stored along with the date and time of the reading as an "altitude record". You can later recall an altitude record to view it.

Important!

- The watch has memory for storage of up to 40 records of various types. If you perform an operation that creates a new record while there are already 40 records in memory, the oldest record is deleted automatically to make room for the new one (page E-70). Note that altitude differential graph and altitude tendency graph information is not stored as part of an altitude record.

To save a reading manually

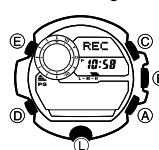

- In the Altimeter Mode, hold (C) for at least two seconds.
 - REC and Hold will appear on the display first, and then Hold will disappear. Release (C) after Hold disappears.
 - The watch will create a record of the current altitude reading along with the date and time, and then return automatically to the altitude reading screen.
- To view a record, enter the Data Recall Mode (page E-26) and use the (A) and (C) buttons to scroll. See "Viewing Memory Records" (page E-70) for more information.

E-44

E-45

Auto Save Values

The watch automatically keeps track of the four types of values below, and updates them as required along with the time and date of the reading.

- High Altitude (MAX)
- Low Altitude (MIN)
- Cumulative Ascent (ASC)
- Cumulative Descent (DSC)

- For detailed information about each value, see page E-47.
- For information about viewing these values, see "Viewing Memory Records" (page E-70).
- These values are checked and updated automatically by the watch as altitude auto measurements are taken. You can change the auto save interval, if you want (page E-37).
- Auto save is performed only while the watch is in the Altimeter Mode.

How Cumulative Ascent and Cumulative Descent Values Are Updated

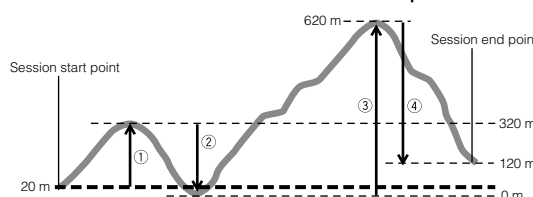

The total ascent and total descent values produced by an Altimeter Mode reading operation session during the example climb illustrated above are calculated as follows.

Total Ascent: ① (300 m) + ③ (620 m) = 920 m
 Total Descent: ② (320 m) + ④ (500 m) = 820 m

- Cumulative ascent and cumulative descent values are updated whenever there is a difference of at least ±15 meters (±49 feet) from one reading to the next.
- ASC and DSC values are retained in memory without being reset even if you exit the Altimeter Mode. When you re-enter the Altimeter Mode, accumulation resumes from the value where it last stopped. See page E-74 for information about how to reset the ASC and DSC values to zero.

E-46

E-47

How does the altimeter work?

Generally, air pressure decreases as altitude increases. This watch bases its altitude reading on International Standard Atmosphere (ISA) values stipulated by the International Civil Aviation Organization (ICAO). These values define relationships between altitude and air pressure.

Altitude	Air Pressure	
4000 m	616 hPa	About 8 hPa per 100 m
3500 m	701 hPa	
3000 m	795 hPa	About 9 hPa per 100 m
2500 m	899 hPa	
2000 m	1013 hPa	About 10 hPa per 100 m
1500 m	1127 hPa	
1000 m	1250 hPa	About 11 hPa per 100 m
500 m	1383 hPa	
0 m	1013 hPa	About 12 hPa per 100 m

Altitude	Air Pressure	
14000 ft.	19.03 inHg	About 0.15 inHg per 200 ft.
12000 ft.	22.23 inHg	
10000 ft.	25.84 inHg	About 0.17 inHg per 200 ft.
8000 ft.	29.92 inHg	
6000 ft.	34.50 inHg	About 0.192 inHg per 200 ft.
4000 ft.	39.08 inHg	
2000 ft.	43.66 inHg	About 0.21 inHg per 200 ft.
0 ft.	48.24 inHg	

Source: International Civil Aviation Organization

- * Note that the following conditions will prevent you from obtaining accurate readings:
 - When air pressure changes because of changes in the weather
 - Extreme temperature changes
 - When the watch itself is subjected to strong impact

There are two standard methods of expressing altitude: absolute altitude, which expresses an absolute height above sea level, and relative altitude, which expresses the difference between the altitudes of two different places. This watch expresses altitudes as relative altitude.

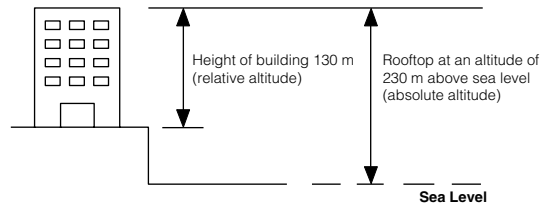

How the Altimeter Measures Altitude

The altimeter can measure altitude based on its own preset values (initial default method) or using a reference altitude specified by you.

When you measure altitude based on preset values

Data produced by the watch's barometric pressure sensor is converted to approximate altitude based on ISA (International Standard Atmosphere) conversion values stored in watch memory.

When you measure altitude using a reference altitude specified by you

After you specify a reference altitude, the watch uses that value to convert barometric pressure readings to altitude (page E-44).

- * When mountain climbing, you can specify a reference altitude value in accordance with a marker along the way or altitude information from a map. After that, the altitude readings produced by the watch will be more accurate than they would without a reference altitude value.



Altimeter Precautions

- * This watch estimates altitude based on air pressure. This means that altitude readings for the same location may vary if air pressure changes.
- * Do not rely upon this watch for altitude reading or perform button operations while sky diving, hang gliding, or paragliding, while riding a gyrocopter, glider, or any other aircraft, or while engaging in any other activity where there is the chance of sudden altitude changes.
- * Do not use this watch for measuring altitude in applications that demand professional or industrial level precision.
- * Remember that the air inside of a commercial aircraft is pressurized. Because of this, the readings produced by this watch will not match the altitude readings announced or indicated by the flight crew.

Precautions Concerning Simultaneous Altitude and Temperature Readings

For the more accurate altitude readings, leaving the watch on your wrist is recommended in order to maintain the watch at a constant temperature.

- * When taking temperature readings, keep the watch at as stable a temperature as possible. Changes in temperature can affect temperature readings. See product specifications (page E-100) for sensor accuracy information.

Taking Direction Readings

You can use the watch to take direction readings to determine a direction (north, south, east, west) or to find out your bearing to a destination.

- * For information about what you can do to ensure direction readings are accurate, see "Magnetic Declination Correction" (page E-58) and "Digital Compass Precautions" (page E-59).

Correcting Direction Reading Error (2-point Calibration)

Use 2-point calibration to correct for measurement error due to local magnetism or other causes.

Important!

- * Keep the watch level during the calibration process.
- * Keep the watch away from electrical household appliances and office equipment, cellphones, and other sources of strong magnetism during calibration. Such items can make proper calibration impossible.

To perform 2-point calibration



1. Enter the Digital Compass Mode (page E-27).
2. Hold down (PS) for at least two seconds. Release the button when -1- appears on the display.

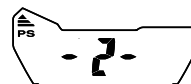

3. Press (C).

- * This starts calibration of point 1. After calibration of point 1 is complete, **TURN 180°** appears on the display, followed by **-2-**.

- * If **ERR** appears on the display, press (C) and then perform calibration of point 1 again.

4. Rotate the watch as precisely as possible 180 degrees from point 1.

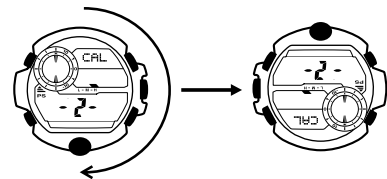

5. Press (C).

- * This starts calibration of point 2. **OK** appears on the display after calibration is complete. After one second, the watch will return to the direction reading screen.
- * If **ERR** appears on the display, perform the procedure from step 3 again.

To take a direction reading

Important!

- * To ensure accuracy, be sure to perform 2-point calibration under actual measurement conditions before taking direction readings.

1. Enter the Digital Compass Mode (page E-27).

- * The watch will automatically start taking direction readings. Readings will be taken and the display will be updated every second for about 60 seconds. At this point you can check the direction (north, south, east west) reading.

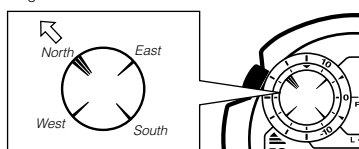

2. During the approximately 60 seconds that the above reading operation is in progress, point 12 o'clock on the watch in the direction of the bearing you want to read.

- * About one second later, the direction and bearing to your objective will appear on the display.
- * If 60 seconds elapse before you can take a bearing reading, press (C) to restart the direction reading operation.

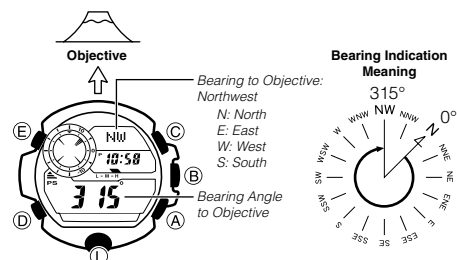

Note

- * The north indicated by the watch is magnetic north (page E-59).
- * If you want to display true north, see "Magnetic Declination Correction" (page E-58).
- * If only north is indicated on the display (without south, east, or west), it means that bearing memory contents are displayed. Press (A) to clear bearing memory contents (page E-56).
- * You can return to the Timekeeping Mode by pressing (C) any time a reading operation is in progress or stopped.

Example: Positioning a map in accordance with actual surroundings (setting a map)

You can align a map with the northerly direction indicated by the watch, and then compare what is shown on the map with your actual surroundings. This is helpful for checking your current location and the location of your objective. This process is called "setting a map".

Saving a Bearing (Bearing Memory)

You can save the bearing to a particular destination in bearing memory and use it to ensure you are headed in the correct direction.

- While the direction and bearing to your objective (page E-54) are displayed, press (A).
 - This saves the objective information in bearing memory, and displays it as shown below. Now, any time you are in the Digital Compass Mode, you can check the objective information currently stored in bearing memory.

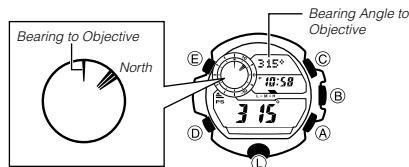

- To return to direction (north, south, east, west) indication, press (A) to delete bearing memory contents.

Example: Advancing to an objective while monitoring your bearing

Even if you lose sight of your objective, you can use a map to store the required bearing in bearing memory and refer to the memorized information to advance to your objective.

E-56

- Set the map (page E-56).
- Place the watch on the map at your current location, and point 12 o'clock at your desired objective on the map.
- Press (A) to store the direction to your objective in bearing memory. Now you can advance towards your objective while observing the stored direction on the watch display.

Important!

- As you progress, the direction to your bearing will change, so you need to keep updating the information in bearing memory.

Using Bearing Records

You can use the procedure in this section to create a bearing record of your current bearing reading, along with the date and time of the reading. You can later recall a record to view it.

Important!

- The watch has memory for storage of up to 40 records of various types. If you perform an operation that creates a new record while there are already 40 records in memory, the oldest record is deleted automatically to make room for the new one (page E-70).

- Take a bearing reading to your objective so it is shown on the display.
- Without moving the watch, hold down (C) for at least two seconds.
 - REC** and **Hold** will appear on the display first, and then **Hold** will disappear. Release (C) after **Hold** disappears.
 - The watch will create a record of the current bearing to your objective along with the date and time, and then return automatically to the direction reading screen.
- To view a record, enter the Data Recall Mode (page E-26) and use the (A) and (C) buttons to scroll (page E-70).

E-57

Magnetic Declination Correction

With magnetic declination correction, you input a magnetic declination angle (difference between magnetic north and true north), which allows the watch to indicate true north. You can perform this procedure when the magnetic declination angle is indicated on the map you are using. Note that you can input the declination angle in whole degree units only, so you may need to round off the value specified on the map. If your map indicates the declination angle as 7.4°, you should input 7°. In the case of 7.6° input 8°, for 7.5° you can input 7° or 8°.

To perform magnetic declination correction

Magnetic declination angle direction value (E, W, or OFF)

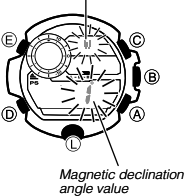

- In the Digital Compass Mode, hold down the watch's (E) button for at least two seconds. Release (E) after **-1-** appears.
- Press (D).
 - DEC** will appear on the display and then the current magnetic declination angle setting will flash on the display.
- Use (A) (East) and (C) (West) to change the settings.
 - The following explains magnetic declination angle direction settings.
 - OFF:** No magnetic declination correction performed. The magnetic declination angle with this setting is 0°.
 - E:** When magnetic north is to the east (east declination)
 - W:** When magnetic north is to the west (west declination)
 - You can select a value within the range of W 90° to E 90° with these settings.
 - You can turn off (**OFF**) magnetic declination correction by pressing (A) and (C) at the same time.

E-58

- The illustration, for example, shows the value you should input and the direction setting you should select when the map shows a magnetic declination of 1° West.

- When the setting is the way you want, press (E) to exit the setting screen.

Digital Compass Precautions

Magnetic North and True North

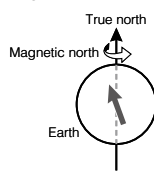

The northerly direction can be expressed either as magnetic north or true north, which are different from each other. Also, it is important to keep in mind that magnetic north moves over time.

- Magnetic north is the north that is indicated by the needle of a compass.
- True north, which is the location of the North Pole of the Earth's axis, is the north that is normally indicated on maps.
- The difference between magnetic north and true north is called the "declination". The closer you get to the North Pole, the greater the declination angle.

Location

- Taking a direction reading when you are near a source of strong magnetism can cause large errors in readings. Because of this, you should avoid taking direction readings while in the vicinity of the following types of objects: permanent magnets (magnetic necklaces, etc.), concentrations of metal (metal doors, lockers, etc.), high tension wires, aerial wires, household appliances (TVs, personal computers, washing machines, freezers, etc.).
- Accurate direction readings are impossible while in a train, boat, air plane, etc.
- Accurate readings are also impossible indoors, especially inside ferroconcrete structures. This is because the metal framework of such structures picks up magnetism from appliances, etc.

E-59

Storage

- The precision of the bearing sensor may deteriorate if the watch becomes magnetized. Because of this, you should store the watch away from magnets or any other sources of strong magnetism, including: permanent magnets (magnetic necklaces, etc.) and household appliances (TVs, personal computers, washing machines, freezers, etc.).
- Whenever you suspect that the watch may have become magnetized, perform the procedure under "To perform 2-point calibration" (page E-52).

E-60

Taking Barometric Pressure and Temperature Readings

This watch uses a pressure sensor to measure air pressure (barometric pressure) and a temperature sensor to measure temperature.

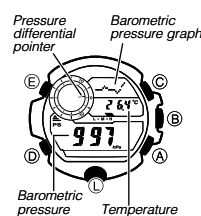

To take barometric pressure and temperature readings

- Enter the Barometer/Thermometer Mode (page E-27).
- This will automatically start a barometric pressure/temperature reading operation, and the results will appear on the display in about one second.
- Readings will continue to be taken about every five seconds for the first three minutes, and then about every two minutes thereafter.
- You can restart the reading operation from the beginning at any time by pressing (C).

Note

- Press (D) to return to the Timekeeping Mode.
- The watch will return to the Timekeeping Mode automatically if you do not perform any operation for about 1 hour after entering the Barometer/Thermometer Mode.

Reading the Barometric Pressure Graph

The barometric pressure graph shows a chronological history of pressure readings.

- When display of the barometric change indicator is disabled, the graph shows the results of up to 21 barometric pressure readings (42 hours).
- When display of the barometric change indicator is enabled, the graph shows the results of up to 11 barometric pressure readings (22 hours).

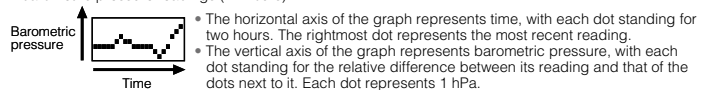

The following shows how to interpret the data that appears on the barometric pressure graph.



Rising barometric pressure indicates that upcoming weather will improve.



Falling barometric pressure indicates that upcoming weather will deteriorate.

Note

- If there are sudden changes in weather or temperature, the graph line of past reading may run off the top or bottom of the display. The entire graph will become visible once barometric conditions stabilize.
- The following conditions cause the barometric pressure reading to be skipped, with the corresponding point on the barometric pressure graph being left blank.
 - Barometric reading that is out of range (260 hPa to 1,100 hPa or 7.65 inHg to 32.45 inHg)
 - Sensor malfunction

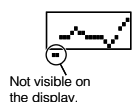

Not visible on the display.

E-62

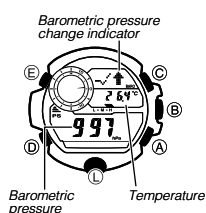

Barometric Pressure

- Barometric pressure is displayed in units of 1 hPa (or 0.05 inHg).
- The displayed barometric pressure value changes to --- if a measured barometric pressure falls outside the range of 260 hPa to 1,100 hPa (7.65 inHg to 32.45 inHg). The barometric pressure value will reappear as soon as the measured barometric pressure is within the allowable range.

Temperature

- Temperature is displayed in units of 0.1°C (or 0.2°F).
- The displayed temperature value changes to --- °C (or °F) if a measured temperature falls outside the range of -10.0°C to 60.0°C (14.0°F to 140.0°F). The temperature value will reappear as soon as the measured temperature is within the allowable range.

Display Units

You can select either hectopascals (hPa) or inchesHg (inHg) as the display unit for the measured barometric pressure, and Celsius (°C) or Fahrenheit (°F) as the display unit for the measured temperature value. See "To specify temperature, barometric pressure, and altitude display units" (page E-35).

Barometric Pressure Graph

Barometric pressure graph



Barometric pressure indicates changes in the atmosphere. By monitoring these changes you can predict the weather with reasonable accuracy. This watch takes barometric pressure readings automatically every two hours. Readings are used to produce barometric pressure graph and barometric pressure differential pointer readings.

E-63

Barometric Pressure Differential Pointer



This pointer indicates the relative difference between the most recent barometric pressure reading indicated on the barometric pressure graph (page E-62), and the current barometric pressure value displayed in the Barometer/Thermometer Mode (page E-61).

Reading Barometric Pressure Differential Pointer

Pressure differential is indicated in the range of ± 10 hPa, in 1-hPa units.

- The nearby illustration, for example, shows what the pointer would indicate when the calculated pressure differential is approximately -5 hPa (approximately -0.15 inHg).
- Barometric pressure is calculated and displayed using hPa as the standard. The barometric pressure differential also can be read in inHg units as shown in the illustration ($1 \text{ hPa} \approx 0.03 \text{ inHg}$).

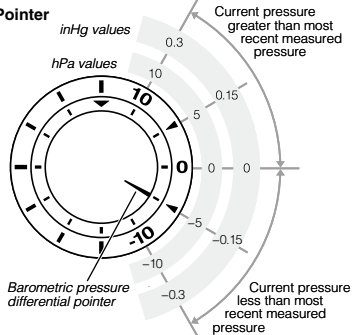

E-64

Barometric Pressure Change Indications

Your watch analyzes past barometric pressure readings and uses a barometric pressure change indicator to inform you about changes in pressure. The watch will beep to let you know when a significant change in barometric pressure is detected. This means you could start taking barometric pressure readings after reaching a lodge or camp area, and then check the watch the next morning for changes in pressure, and plan your day's activities accordingly. Note that you can enable or disable display of the barometric pressure change indicator as desired.

Reading the Barometric Pressure Change Indicator

Indicator	Meaning
	Sudden fall in pressure.
	Sudden rise in pressure.
	Sustained rise in pressure, changing to a fall.
	Sustained fall in pressure, changing to a rise.

- The barometric pressure change indicator is not displayed if there has been no noteworthy change in barometric pressure.

E-65

Important!

- To ensure proper results, take barometric readings under conditions where the altitude remains constant.

Example

- In a lodge or campground
- On the ocean

- A change in altitude causes a change in barometric pressure. Because of this, correct readings are impossible. Do not take readings while ascending or descending a mountain, etc.

Enabling or Disabling Display of the Barometric Pressure Change Indicator

You can enable or disable display of the barometric pressure change indicator as desired. When display of the indicator is enabled, the watch will take a barometric pressure reading every two minutes, regardless of the mode it is in.

- When **BARO** is shown on the display, it means that barometric pressure change indicator display is enabled.

To enable or disable the barometric pressure change alert

In the Barometer/Thermometer Mode, hold down (A) for at least two seconds. Keep (A) depressed until the current setting (**INFO Hold ON** or **INFO Hold OFF**) starts to flash on the display.

- If barometric pressure change indicator display is currently enabled, **BARO** will also appear in the display. **BARO** will not appear if display is currently disabled.
- Note that barometric pressure change indicator display will turn off automatically 24 hours after you turn it on or battery power goes low.
- Note that time calibration signal reception and power saving (page E-14) are disabled while barometric pressure change indicator display is enabled.
- Note that barometric pressure change indicator display cannot be enabled while the watch's battery is low.

E-66

Using Barometric Pressure and Temperature Records

You can use the procedure in this section to create a barometric pressure and temperature record of your current readings, along with the date and time of the reading. You can later recall a record to view it.

Important!

- The watch has memory for storage of up to 40 records of various types. If you perform an operation that creates a new record while there are already 40 records in memory, the oldest record is deleted automatically to make room for the new one (page E-70).

- While barometric pressure and temperature readings are in progress, hold down (C) for at least two seconds.
 - REC** and **Hold** will appear on the display first, and then **Hold** will disappear. Release (C) after **Hold** disappears.
 - The watch will create a record of the current barometric pressure and temperature, along with the date and time, and then return automatically to the barometric pressure/temperature reading screen.
- To view a record, enter the Data Recall Mode (page E-26) and use the (A) and (C) buttons to scroll. See "Viewing Memory Records" (page E-70) for more information.

Pressure Sensor and Temperature Sensor Calibration

The pressure sensor and temperature sensor built into the watch are calibrated at the factory and normally require no further adjustment. If you notice serious errors in the pressure readings and temperature readings produced by the watch, you can calibrate the sensor to correct the errors.

Important!

- Incorrectly calibrating the barometric pressure sensor can result in incorrect readings. Before performing the calibration procedure, compare the readings produced by the watch with those of another reliable and accurate barometer.

E-67

- Incorrectly calibrating the temperature sensor can result in incorrect readings. Carefully read the following before doing anything.
 - Compare the readings produced by the watch with those of another reliable and accurate thermometer.
 - If adjustment is required, remove the watch from your wrist and wait for 20 or 30 minutes to give the temperature of the watch time to stabilize.

To calibrate the pressure sensor and the temperature sensor

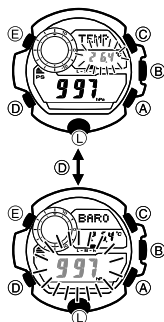

- Take a reading with another measurement device to determine the exact current barometric pressure or temperature.
- In the Barometer/Thermometer Mode, hold down (E) for at least two seconds. You can release (E) after **TEMP** appears.
 - The current temperature calibration setting will flash in the display at this time.
- Press (D) to move the flashing between the temperature value and barometric pressure value, to select the one you want to calibrate.
- Use (A) (+) and (C) (-) to select the temperature and barometric pressure value display units as shown below.

Temperature	0.1°C (0.2°F)
Barometric Pressure	1 hPa (0.05 inHg)

 - To return the currently flashing value to its initial factory default setting, press (A) and (C) at the same time. **OFF** will appear at the flashing location for about one second, followed by the initial default value.
- Press (E) to return to the Barometer/Thermometer Mode screen.

E-68

Barometer and Thermometer Precautions

- The pressure sensor built into this watch measures changes in air pressure, which you can then apply to your own weather predictions. It is not intended for use as a precision instrument in official weather prediction or reporting applications.
- Sudden temperature changes can affect pressure sensor readings. Because of this, there may be some error in the readings produced by the watch.
- Temperature reading are affected by your body temperature, direct sunlight, and moisture. To achieve a more accurate temperature reading, remove the watch from your wrist, place it in a well ventilated location out of direct sunlight, and wipe all moisture from the case. It takes approximately 20 to 30 minutes for the case of the watch to reach the surrounding temperature.

E-69

Viewing Memory Records

You can use the Data Recall Mode to recall and view the following type of data in watch memory.

- Date/Time Records (page E-30)
- Altitude Records (page E-45)
- Historical altitude values (page E-46)
- Direction Records (page E-56)
- Barometric Pressure and Temperature Records (page E-67)

To view data in watch memory

- Use (D) to select the Data Recall Mode (**REC**) as shown on page E-26.
 - About one second after **REC** appears on the display, the display will change to show the first record of the memory area you were viewing when you last exited the Data Recall Mode.
- Use (A) and (C) to scroll through the screens for an area and display the one you want.
 - Records are assigned numbers in the sequence they are recorded. If you create a new record (by saving data) while there are already 40 records in memory, record number 01 (the oldest record) will be deleted automatically to make room for the new record.
 - If you attempt to recall a record while there are no records in memory, a blank record will appear on the display.
 - Holding the (A) or (C) button will scroll through the records at high speed.

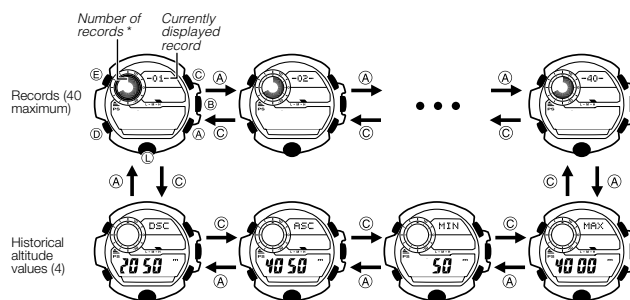

* Segment indicating currently displayed record flashes.



E-70

E-71

Records

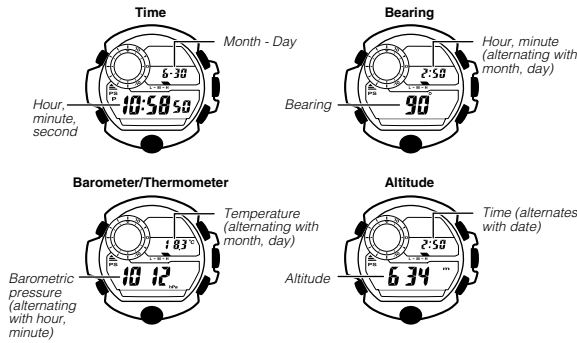

E-72

Historical Altitude Values

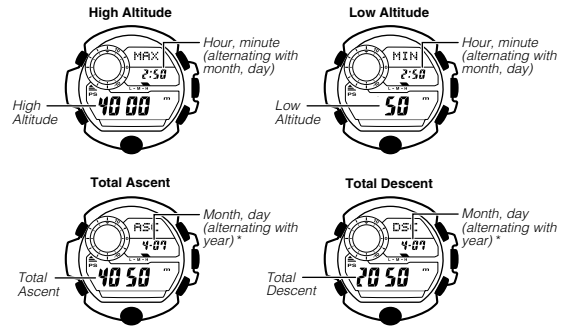

* During display of the cumulative ascent or cumulative descent value, shows the cumulation start date.

E-73

To delete all saved data

Important!

A delete operation cannot be undone! Make sure you do not need data before you delete it.
In the Data Recall Mode, hold down (E) for at least five seconds. **Hold** will flash on the display first for about two seconds and then disappear. Keep (E) depressed. **Hold** will start flashing again and then it will disappear after about five seconds. Release (E) at this time, --- will appear on the display to indicate that all the data was deleted.

To delete a specific record

Important!

A delete operation cannot be undone! Make sure you do not need data before you delete it.
1. In the Data Recall Mode, use (A) and (C) to scroll through records in watch memory until the one you want to delete is displayed.
2. Hold down (E) for at least two seconds. First, **CLEAR Hold** will flash in the display. After that, **Hold** will disappear. Release (E) when **Hold** disappears.

CAUTION!

Holding down (E) for more than about five seconds will delete all data currently in watch memory.

E-74

Checking the Current Time in a Different Time Zone

You can use the World Time Mode to view the current time in one of 31 time zones (48 cities) around the globe. The city that is currently selected in the World Time Mode is called the "World Time City".

To enter the World Time Mode

Use (D) to select the World Time Mode (WT) as shown on page E-26.

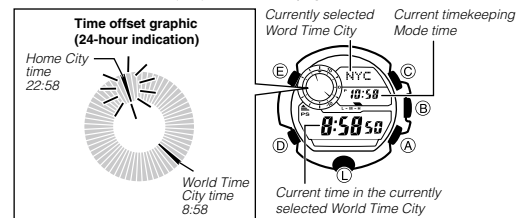

* After about one second, the city code and name of the currently selected city will scroll across the display. After that, the city code only will remain on the display.

To view the time in another time zone

In the World Time Mode, use (A) (East) and (C) (West) to scroll through city codes.

E-75

To specify standard time or daylight saving time (DST) for a city

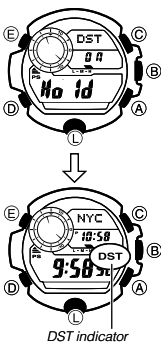

1. In the World Time Mode, use (A) (East) and (C) (West) to scroll through the available city codes.

Keep scrolling until the city code whose Standard Time/Daylight Saving Time setting you want to change is displayed.

2. Hold down (E) for at least two seconds. **DST** and **Hold** will appear on the display first, and then **Hold** will disappear. Release (E) after **Hold** disappears.

- This will toggle summer time between on and off.
- The **DST** indicator is displayed while summer time is turned on.
- Using the World Time Mode to change the DST setting of the city code that is selected as your Home City also will change the Timekeeping Mode time DST setting.
- Note that you cannot switch between standard time/daylight saving time (DST) while **UTC** is selected as the World Time City.
- Note that the standard time/daylight saving time (DST) setting affects only the currently selected city. Other cities are not affected.

E-76

Using the Stopwatch

The stopwatch measures elapsed time, split times, and two finishes.

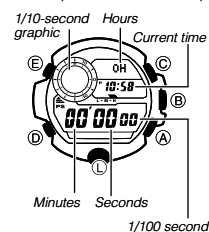

To enter the Stopwatch Mode

Use (D) to select the Stopwatch Mode (STW) as shown on page E-26.

To perform an elapsed time operation

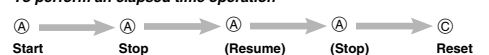

To pause at a split time



To measure two finishes

Note

- The Stopwatch Mode can indicate elapsed time up to 999 hours, 59 minutes, 59.99 seconds.
- Once started, stopwatch timing continues until you press (A) to stop it, even if you exit the Stopwatch Mode to another mode and even if timing reaches the stopwatch limit defined above. A paused timing operation will remain paused until you press (A) to resume it or (C) to reset.
- Exiting the Stopwatch Mode while a split time is frozen on the display clears the split time and returns to elapsed time measurement.
- While **SPLIT** is shown in the display, it alternates with the hour digits of the split time at one-second intervals.
- You can directly access the Stopwatch Mode from the Timekeeping Mode by pressing the (A) button. If the stopwatch is reset to all zeros when you enter the Stopwatch mode, the watch will beep twice and an elapsed time operation will start automatically. You can check whether the stopwatch is reset by looking at the Timekeeping Mode graphic (page E-29).

E-78

Using the Countdown Timer

The countdown timer can be configured to start at a preset time, and sound an alarm when the end of the countdown is reached.

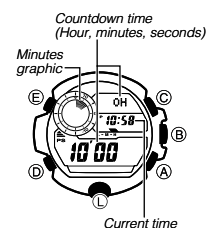

To enter the Countdown Timer Mode

Use (D) to select the Countdown Timer Mode (TMR) as shown on page E-26.

To specify the countdown start time

- Enter the Countdown Timer Mode.
 - If a countdown is in progress (indicated by the seconds counting down), press (A) to stop it and then press (C) to reset to the current countdown start time.
 - If a countdown is paused, press (C) to reset to the current countdown start time.
- Hold down (E) for at least two seconds.
 - SET Hold** will flash on the display and then the current start time setting will start to flash. Keep (E) depressed until the start time setting starts to flash.

- Press (D) to move the flashing between the hour and minute settings.
- Use (A) (+) and (C) (-) to change the flashing item.
 - To set the starting value of the countdown time to 24 hours, set **0H 00'00**.
- Press (E) to exit the setting screen.

E-79

To perform a countdown timer operation



- Before starting a countdown timer operation, check to make sure that a countdown operation is not in progress (indicated by the seconds counting down). If it is, press (A) to stop it and then (C) to reset to the countdown start time.
- An alarm sounds for ten seconds when the end of the countdown is reached. This alarm will sound in all modes. The countdown time is reset to its starting value automatically when the alarm sounds.

To stop the alarm

Press any button.

E-80

Using the Alarm

You can set five independent daily alarms. When an alarm is turned on, an alarm will sound for about 10 seconds each day when the time in the Timekeeping Mode reaches the preset alarm time. This is true even if the watch is not in the Timekeeping Mode. One of the daily alarms is a snooze alarm. The other four are one-time alarms. The snooze alarm will sound every five minutes up to seven times or until it is turned off. You can also turn on an Hourly Time Signal, which will cause the watch to beep twice every hour on the hour.

To enter the Alarm Mode

Use (D) to select the Alarm Mode (ALM) as shown on page E-26.

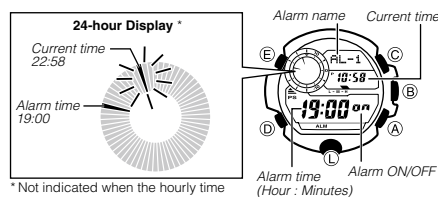

* Not indicated when the hourly time signal screen is displayed.

- The alarm name indicates an alarm screen. **SIG** is shown when the Hourly Time Signal screen is on the display.
- When you enter the Alarm Mode, the data you were viewing when you last exited the mode appears first.

E-81

To set an alarm time

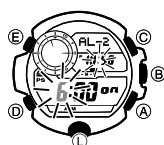

1. In the Alarm Mode, use (A) to scroll through the alarm screens until the one whose time you want to set is displayed.

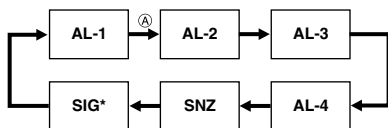

* There is no time setting for the hourly time signal.

2. Hold down (E) until **SET Hold** appears on the display and then the current settings start to flash.
 - This is the setting screen.
3. Press (D) to move the flashing between the hour and minute settings.
4. While a setting is flashing, use (A) (+) and (C) (-) to change it.
 - When setting the alarm time using the 12-hour format, take care to set the time correctly as a.m. (no indicator) or p.m. (P indicator).
5. Press (E) to exit the setting screen.
 - Setting an alarm time causes that alarm to turn on automatically.

E-82

To turn an alarm and the Hourly Time Signal on and off



Snooze alarm indicator
Hourly time signal on indicator
Alarm on indicator

1. In the Alarm Mode, use (A) to select an alarm or the Hourly Time Signal.
2. When the alarm or the Hourly Time Signal you want is selected, press (C) to turn it on and off.
 - The alarm on indicator (when any alarm is on), snooze alarm indicator (when the snooze alarm is on), and the Hourly Time Signal on indicator (when the Hourly Time Signal is on) are shown on the display in all modes.

To stop the alarm
Press any button.

Note

- The snooze alarm sounds up to seven times at intervals of about five minutes.
- After the snooze alarm first sounds, **SNZ** will flash on the display until the snooze alarm sounds all seven times or until it is canceled.
- The snooze alarm will be canceled when any of the following occurs while the **SNZ** indicator is flashing on the display.
 - If you turn off the snooze alarm
 - If you display the snooze alarm setting screen
 - If you display the Timekeeping Mode setting screen
 - If your Home City and World Time City are the same city, and you use the World Time Mode to change the summer time setting of your Home City

E-83

Looking up Sunrise and Sunset Times

You can use the Sunrise/Sunset Mode to look up the sunrise and sunset times for a particular date (year, month, day) and location.

To view sunrise and sunset times

Use (D) to select the Sunrise/Sunset Mode (SUN) as shown on page E-26.

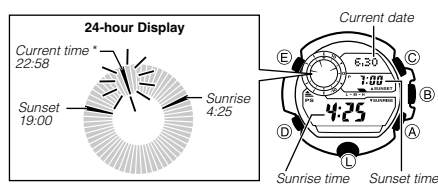

* Indicated only when the displayed date is today's date.

- This will display the sunrise and sunset times for the current date based the currently specified city code, latitude, and longitude.
- Sunrise/sunset times will not be displayed when battery power is low.
- Before trying to use the Sunrise/Sunset Mode, you need to configure settings for the city code, longitude, and latitude for the location whose sunrise and sunset times you want to view.
- The factory default configuration of the location is: City Code: **TYO** (Tokyo); Latitude: North 35.7 degrees; Longitude: East 139.7 degrees.

E-84

To view the sunrise/sunset time for a particular date

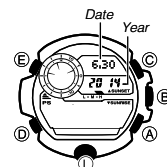

1. Enter the Sunrise/Sunset Mode.
2. While the sunrise/sunset time are on the display, use (A) (+) and (C) (-) to scroll through the dates.
 - Pressing either of the above buttons causes a date (month and day) to appear on the display.
 - When you release the button, the sunrise time of the selected day will be shown in the middle display, while the sunset time will be shown in the lower display.
 - You can select any date between January 1, 2000 and December 31, 2099.

Note

- If you think that the sunrise and/or sunset times are not correct for some reason, check the watch's city code, longitude and latitude settings.
- The sunrise and sunset times displayed by this watch are times at sea level. Sunrise and sunset times are different at altitudes other than sea level.

E-85

To look up the sunrise and sunset times for a specific location

Important!

- If you select a different city code to look up the sunrise and sunset times there, return to the city code of your Home City (your current location) when you are finished. Otherwise, the time shown in the Timekeeping Mode will not be correct.
- For information about the Home City setting, see "Configuring Home City Settings" (page E-31).

1. In the Timekeeping Mode, hold down (E) for at least two seconds. **SET** and **HOLD** will appear on the display first, and then **HOLD** will disappear. Release (E) after **HOLD** disappears.
2. Use (A) (East) and (C) (West) to select the city code whose sunrise and sunset times you want to view.
 - For details about city codes, see the "City Code Table" at the back of this manual.
 - If this display shows the information you need, you can exit this procedure at this point by pressing (E) twice. If you want to specify a latitude and longitude for a more exact reading, advance to step 3, below.

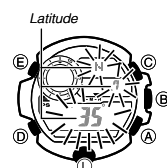

Press (D) ↓

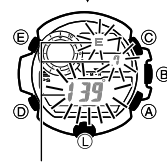

3. Press (E) to display the longitude/latitude setting screen, with the latitude setting flashing.
4. Use (D) to move the flashing between the latitude and the longitude setting.
5. Use (A) (+) and (C) (-) to change the flashing setting.
 - You can configure the longitude and latitude setting within following ranges.
 - Latitude Range: 65.0°S (South 65.0 degrees) to 0°N to 65.0°N (North 65.0 degrees)
 - Longitude Range: 179.9°W (West 179.9 degrees) to 0°E to 180.0°E (East 180.0 degrees)
 - Latitude and longitude values are rounded off to the nearest degree.
6. Press (E) to return to the Timekeeping Mode.
7. Use (D) to select the Sunrise/Sunset Mode (SUN) as shown on page E-26.
 - Display the location whose sunrise and sunset times you want to view.

E-86

E-87

Illumination



The display of the watch is illuminated for easy reading in the dark. The watch's auto light switch turns on illumination automatically when you angle the watch towards your face.

- The auto light switch must be turned on (page E-90) for it to operate.

To turn on illumination manually

Press (L) in any mode to illuminate the display.

- You can use the procedure below to select either 1.5 seconds or three seconds as the illumination duration. When you press (L), the display will remain illuminated for about 1.5 seconds or three seconds, depending on the current illumination duration setting.
- The above operation turns on illumination regardless of the current auto light switch setting.
- Illumination is disabled during time calibration signal reception, while configuring sensor measurement mode settings, and during bearing sensor calibration.

To change the illumination duration

- In the Timekeeping Mode, hold down (E) for at least two seconds. **SET** and **Hold** will appear on the display first, and then **Hold** will disappear. Release (E) after **Hold** disappears.
- Use (D) to cycle through the setting screens until **LIGHT** appears in the display.
 - The current illumination duration setting (1 or 3) will be flashing in the middle display.
 - See the sequence in step 2 of the procedure under "To change the current time and date settings manually" (page E-33) for information about how to scroll through setting screens.

E-88

- Press (A) to toggle the illumination duration between three seconds (3 displayed) and 1.5 seconds (1 displayed).
- After all of the settings are the way you want, press (E) twice to exit the setting screen.

About the Auto Light Switch

Turning on the auto light switch causes illumination to turn on, whenever you position your wrist as described below in any mode. **Moving the watch to a position that is parallel to the ground and then tilting it towards you more than 40 degrees causes illumination to turn on.**



Warning!

- Always make sure you are in a safe place whenever you are reading the display of the watch using the auto light switch. Be especially careful when running or engaged in any other activity that can result in accident or injury. Also take care that sudden illumination by the auto light switch does not startle or distract others around you.
- When you are wearing the watch, make sure that its auto light switch is turned off before riding on a bicycle or operating a motorcycle or any other motor vehicle. Sudden and unintended operation of the auto light switch can create a distraction, which can result in a traffic accident and serious personal injury.

Note

- This watch features a "Full Auto Light", so the auto light switch operates only when available light is below a certain level. It does not illuminate the display under bright light.
- The auto light switch is always disabled, regardless of its on/off setting, when any one of the following conditions exists.

While an alarm is sounding
 While a bearing sensor calibration operation is being performed in the Digital Compass Mode
 While a receive operation is in progress in the Receive Mode
 While a sunrise or sunset time is being calculated
 While in a sensor mode, an auto light switch operation is performed after a sensor reading

To turn the auto light switch on and off

In the Timekeeping Mode, hold down (L) for at least three seconds to toggle the auto light switch on (**LT** displayed) and off (**LT** not displayed).

- The auto light switch turns off automatically whenever battery power drops to Level 4 (page E-11).



E-90

Illumination Precautions

- The LED that provides illumination loses power after very long use.
- Illumination may be hard to see when viewed under direct sunlight.
- Illumination turns off automatically whenever an alarm sounds.
- Frequent use of illumination runs down the battery.

Auto light switch precautions

- Wearing the watch on the inside of your wrist, movement of your arm, or vibration of your arm can cause frequent activation of the auto light switch and illumination of the display. To avoid running down the battery, turn off the auto light switch whenever engaging in activities that might cause frequent illumination of the display.
- Note that wearing the watch under your sleeve while the auto light switch is turned on can cause frequent illumination of the display and can run down the battery.



- Illumination may not turn on if the face of the watch is more than 15 degrees above or below parallel. Make sure that the back of your hand is parallel to the ground.
- Illumination turns off after the preset illumination duration (page E-88), even if you keep the watch pointed towards your face.
- Static electricity or magnetic force can interfere with proper operation of the auto light switch. If illumination does not turn on, try moving the watch back to the starting position (parallel with the ground) and then tilt it back towards your face again. If this does not work, drop your arm all the way down so it hangs at your side, and then bring it back up again.
- You may notice a very faint clicking sound coming from the watch when it is shaken back and forth. This sound is caused by mechanical operation of the auto light switch, and does not indicate a problem with the watch.

E-89

E-91

Other Settings

Button Operation Tone

The button operation tone sounds any time you press one of the watch's buttons. You can turn the button operation tone on or off as desired.

- Even if you turn off the button operation tone, the alarm, Hourly Time Signal, barometric pressure change alert, and Countdown Timer Mode alarm all operate normally.

To turn the button operation tone on and off

- In the Timekeeping Mode, hold down (E) for at least two seconds. **SET** and **Hold** will appear on the display first, and then **Hold** will disappear. Release (E) after **Hold** disappears.
- Use (D) to cycle through settings on the display until the current button operation tone (**MUTE** or **KEY**) is displayed.
 - See the sequence in step 2 of the procedure under "To change the current time and date settings manually" (page E-33) for information about how to scroll through setting screens.
- Press (A) to toggle the button operation tone on (**KEY**) and off (**MUTE**).
- After all of the settings are the way you want, press (E) twice to exit the setting screen.

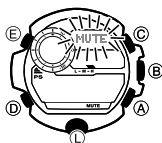

Note

- The mute indicator is displayed in all modes when the button operation tone is turned off.

E-92

Power Saving

For details about Power Saving, see page E-14.

To turn Power Saving on or off

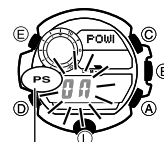

Power saving on indicator

- In the Timekeeping Mode, hold down (E) for at least two seconds. **SET** and **Hold** will appear on the display first, and then **Hold** will disappear. Release (E) after **Hold** disappears.
- Use (D) to cycle through the setting screens until the current power saving setting (**On** or **OFF**) is displayed.
 - POWER SAVING** will scroll across the upper display at this time.
 - See the sequence in step 2 of the procedure under "To change the current time and date settings manually" (page E-33) for information about how to scroll through setting screens.
- Press (A) to toggle Power Saving on (**On**) and off (**OFF**).
- After all of the settings are the way you want, press (E) twice to exit the setting screen.

Note

- The Power Saving on indicator (**PS**) is on the display in all modes while Power Saving is turned on.

E-93

Troubleshooting

Time Setting

See "Radio Controlled Atomic Timekeeping" (page E-15) for information about adjusting the time setting according to a time calibration signal.

■ The current time setting is off by hours.

Your Home City setting may be wrong (page E-31). Check your Home City setting and correct it, if necessary.

■ The current time setting is off by one hour.

If you are using the watch in an area where time calibration signal reception is possible, see "To configure Home City and summer time settings" (page E-31).

If you are using in the watch in an area where time calibration signal reception is not possible, you may need to change your Home City's standard time/daylight saving time (DST) setting manually. Use the procedure under "To change the current time and date settings manually" (page E-33) to change the standard time/daylight saving time (DST) setting.

Sensor modes

■ I can't change the temperature, barometric pressure, and altitude display units.

When **TYO** (Tokyo) is selected as the Home City, the altitude unit is set automatically to meters (m), the barometric pressure unit to hectopascals (hPa), and the temperature unit to Celsius (°C). These settings cannot be changed.

E-94

■ "ERR" appears on the display while I am using a sensor.

Subjecting the watch to strong impact can cause sensor malfunction or improper contact of internal circuitry. When this happens, **ERR** (error) will appear on the display and sensor operations will be disabled.

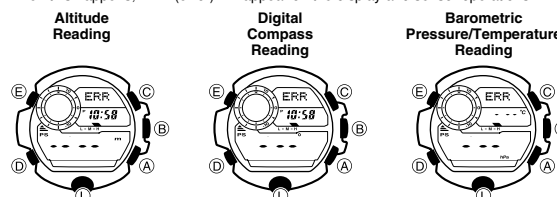

- If **ERR** appears while a reading operation is being performed in a sensor mode, restart the operation. If **ERR** appears on the display again, it can mean there is something wrong with the sensor.
- If **ERR** keeps appearing during a reading operation, it could mean there is a problem with the applicable sensor.

E-95

■ Correct altitude readings are not possible.

Relative altitude is calculated based on changes in barometric pressure readings by the pressure sensor. To minimize the chance of reading error due to changes in barometric pressure, you should update the reference altitude value before setting off on a trek or any other activity where you plan to take altitude readings. For more information, see "To specify a reference altitude value" (page E-44).

■ ERR appears on the display after I perform 2-point calibration.

If -- appears and then changes to ERR (error) on the calibration screen, it means that there is something wrong with the sensor.

- If ERR disappears after about one second, try performing the calibration again.
- If ERR keeps appearing, contact your original dealer or nearest authorized CASIO distributor to have the watch checked.

Whenever you have a sensor malfunction, take the watch to your original dealer or nearest authorized CASIO distributor as soon as possible.

■ What causes incorrect direction readings?

- Incorrect 2-point calibration. Perform 2-point calibration (page E-52).
- Nearby source of strong magnetism, such as a household appliance, a large steel bridge, a steel beam, overhead wires, etc., or an attempt to take direction readings on a train, boat, etc. Move away from large metal objects and try again. Note that digital compass operation cannot be performed inside a train, boat, etc.

■ What causes different direction readings to produce different results at the same location?

Magnetism generated by nearby high-tension wires is interfering with detection of terrestrial magnetism. Move away from the high-tension wires and try again.

■ Why am I having problems taking direction readings indoors?

A TV, personal computer, speakers, or some other object is interfering with terrestrial magnetism readings. Move away from the object causing the interference or take the direction reading outdoors. Indoor direction readings are particularly difficult inside ferro-concrete structures. Remember that you will not be able to take direction readings inside of trains, airplanes, etc.

■ The barometric pressure differential pointer does not appear on the display when I enter the Barometer/Thermometer Mode.

- This could indicate sensor error. Try pressing (B) again.
- The barometric pressure differential pointer is not displayed when the displayed current barometric value is outside of the allowable measurement range (260 to 1,100 hPa).

World Time Mode

■ The time for my World Time City is off in the World Time Mode.

This could be due to incorrect switching between standard time and daylight saving time. See "To specify standard time or daylight saving time (DST) for a city" (page E-76) for more information.

Charging

■ The watch does not resume operation after I expose it to light.

This can happen after the power level drops to Level 5 (page E-11). Continue exposing the watch to light until the battery power indicator shows H or M.

E-96

E-97

Time Calibration Signal

The information in this section applies only when LIS, LON, MAD, PAR, ROM, BER, STO, ATH, MOW, HKG, BJS, HNL, ANC, YVR, LAX, YEA, DEN, MEX, CHI, NYC, YHZ, YYT, TPE, SEL, or TYO is selected as the Home City. You need to adjust the current time manually when any other city is selected as the Home City.

■ The display shows the ERR indicator when I check the result of the latest receive operation.

Possible Cause	Remedy	Page
<ul style="list-style-type: none"> • You are wearing or moving the watch, or performing a button operation during the signal receive operation. • The watch is in an area with poor reception conditions. 	Keep the watch in an area where reception conditions are good while the signal receive operation is performed.	E-17
You are in an area where signal reception is not possible for some reason.	See "Approximate Reception Ranges".	E-16
The calibration signal is not being transmitted for some reason.	<ul style="list-style-type: none"> • Check the website of the organization that maintains the time calibration signal in your area for information about its down times. • Try again later. 	-

■ The current time setting changes after I set it manually.

You may have the watch configured for auto receive of the time calibration signal (page E-18), which will cause the time to be adjusted automatically according to your currently selected Home City. If this results in the wrong time setting, check your Home City setting and correct it, if necessary (page E-31).

E-98

■ The current time setting is off by one hour.

Possible Cause	Remedy	Page
Signal reception on a day for switching between standard time/daylight saving time (DST) may have failed for some reason.	Perform the operation under "To get ready for a receive operation". The time setting will be adjusted automatically as soon as signal reception is successful.	E-17
	If you are unable to receive the time calibration signal, change the standard time/daylight saving time (DST) setting manually.	E-33

■ Auto receive is not performed or you cannot perform manual receive.

Possible Cause	Remedy	Page
The watch is not in the Timekeeping Mode or World Time Mode.	Auto receive is performed only while the watch is in the Timekeeping Mode or World Time Mode. Switch to either of these two modes.	E-26
Your Home City setting is wrong.	Check your Home City setting and correct it, if necessary.	E-31
There is not enough power for signal reception.	Expose the watch to light to charge it.	E-10

■ Signal reception is being performed successfully, but the time and/or day is wrong.

Possible Cause	Remedy	Page
Your Home City setting is wrong.	Check your Home City setting and correct it, if necessary.	E-31
The DST setting may be incorrect.	Change the DST setting to Auto DST.	E-31

E-99

Specifications

Accuracy at normal temperature: ±15 seconds a month (with no signal calibration)

Timekeeping: Hour, minutes, seconds, p.m. (P), year, month, day, day of the week

Time format: 12-hour and 24-hour

Calendar system: Full Auto-calendar pre-programmed from the year 2000 to 2099

Date/Time Records: Up to 40 records (shared storage with altitude, bearing, and barometric pressure/temperature records)

Other: Two display formats (day of the week screen, barometric pressure graph screen); Home City code (can be assigned one of 48 city codes); Standard Time / Daylight Saving Time (summer time) Year display on setting screen only.

Time Calibration Signal Reception: Auto receive 6 times a day (5 times a day for the Chinese calibration signal); Remaining auto receives cancelled as soon as one is successful; Manual receive; Receive Mode

Receivable Time Calibration Signals: Mainflingen, Germany (Call Sign: DCF77, Frequency: 77.5 kHz); Anthorn, England (Call Sign: MSF, Frequency: 60.0 kHz); Fort Collins, Colorado, the United States (Call Sign: WWVB, Frequency: 60.0 kHz); Fukushima, Japan (Call Sign: JJY, Frequency: 40.0 kHz); Fukuoka/Saga, Japan (Call Sign: JJY, Frequency: 60.0 kHz); Shangqiu City, Henan Province, China (Call Sign: BPC, Frequency: 68.5 kHz)

Altimeter:

Measurement range: -700 to 10,000 m (or -2,300 to 32,800 ft.) without reference altitude

Display range: -10,000 to 10,000 m (or -32,800 to 32,800 ft.)

Negative values can be caused by readings produced based on a reference altitude or due to atmospheric conditions.

Display unit: 1 m (or 5 ft.)

E-100

E-101

Thermometer:

Measurement and display range: -10.0 to 60.0°C (or 14.0 to 140.0°F)

Display unit: 0.1°C (or 0.2°F)

Reading timing: Every five seconds in the Barometer/Thermometer Mode

Other: Calibration; Manual reading (button operation)

Temperature Sensor Precision:

±2°C (±3.6°F) in range of -10°C to 60°C (14.0°F to 140.0°F)

Bearing Sensor Precision:

Direction: Within ±10°

Values are guaranteed for a temperature range of -10°C to 60°C (14°F to 140°F).

North pointer: Within ±2 digital segments

Pressure Sensor Precision:

Measurement accuracy: Within ±3hPa (0.1 inHg) (Altimeter accuracy: Within ±75m (246 ft.))

• Values are guaranteed for a temperature range of -10°C to 40°C (14°F to 104°F).

• Precision is lessened by strong impact to either the watch or the sensor, and by temperature extremes.

World Time: 48 cities (31 time zones)

Other: Daylight Saving Time/Standard Time

Stopwatch:

Measuring unit: 1/100 second

Measuring capacity: 99:59:59.99"

Measuring accuracy: ±0.0006%

Measuring modes: Elapsed time, split time, two finishes

E-102

E-103

Current Altitude Data: Every second for the first 3 minutes, followed by every 5 seconds for approximately 1 hour (0'05); every second for the first 3 minutes, followed by every 2 minutes for approximately 12 hours (2'00)

Altitude Records:

Up to 40 records (shared storage with date/time, bearing, and barometric pressure/temperature records)

Historical Altitude Values: 1 record of high altitude, low altitude, cumulative ascent, cumulative descent

Other: Reference altitude setting; Altitude differential; Altitude auto reading interval (0'05 or 2'00); Altitude Differential Graph

Digital Compass:

60 seconds continuous reading; 16 directions; Angle value 0° to 359°; Four direction pointers; Calibration (2-point); Magnetic declination correction; Bearing Memory; Bearing Records: Up to 40 records (shared storage with date/time, altitude, and barometric pressure/temperature records)

Barometer:

Measurement and display range:

260 to 1,100 hPa (or 7.65 to 32.45 inHg)

Display unit: 1 hPa (or 0.05 inHg)

Reading timing: Daily from midnight, at two hour intervals (12 times per day); Every five seconds in the Barometer/Thermometer Mode

Barometric Pressure/Temperature Records: Up to 40 records (shared storage with date/time, altitude, and bearing records)

Other: Calibration; Manual reading (button operation); Barometric pressure graph; Barometric pressure differential pointer; Barometric pressure change indicator

Countdown Timer:

Measuring unit: 1 second

Countdown range: 24 hours

Setting unit: 1 minute

Alarms: 5 Daily alarms (four one-time alarms; one snooze alarm); Hourly time signal

Sunrise/sunset:

Sunrise/sunset time display; selectable date

Illumination: LED light; Selectable illumination duration (approximately 1.5 seconds or 3 seconds); Auto Light Switch (Full Auto Light operates only in the dark)

Other: Battery power indicator; Power Saving; Low-temperature resistance (-10°C/14°F); Button operation tone on/off

Power Supply: Solar panel and one rechargeable battery

Approximate battery operating time: 8 months (from full charge to Level 4) under the following conditions:

- Light: 1.5 seconds/day
- Beeper: 10 seconds/day
- Direction readings: 20 times/month
- Climbs: Once (approximately 1 hour of altitude readings)/month
- Barometric pressure change indicator readings: Approximately 24 hours/month
- Barometric pressure graph: Readings every 2 hours
- Time calibration signal receive: 4 minutes/day
- Display: 16 hours/day

Frequent use of illumination runs down the battery. Particular care is required when using the auto light switch (page E-91).

Operation Guide 3410

CASIO®

City Code Table

City Code	City	UTC Offset/ GMT Differential
PPG	Pago Pago	-11
HNL	Honolulu	-10
ANC	Anchorage	-9
YVR	Vancouver	-8
LAX	Los Angeles	-8
YEA	Edmonton	-7
DEN	Denver	-7
MEX	Mexico City	-6
CHI	Chicago	-6
NYC	New York	-5
SCL	Santiago	-4
YHZ	Halifax	-4
YYT	St. Johns	-3.5
RIO	Rio De Janeiro	-3
FEN	Fernando de Noronha	-2
RAI	Praia	-1

City Code	City	UTC Offset/ GMT Differential
UTC		
LIS	Lisbon	0
LON	London	0
MAD	Madrid	0
PAR	Paris	0
ROM	Rome	+1
BER	Berlin	+1
STO	Stockholm	+1
ATH	Athens	+1
CAI	Cairo	+2
JRS	Jerusalem	+2
MOW	Moscow	+3
JED	Jeddah	+3
THR	Tehran	+3.5
DXB	Dubai	+4
KBL	Kabul	+4.5
KHI	Karachi	+5

City Code	City	UTC Offset/ GMT Differential
DEL	Delhi	+5.5
KTM	Kathmandu	+5.75
DAC	Dhaka	+6
RGN	Yangon	+6.5
BKK	Bangkok	+7
SIN	Singapore	+7
HKG	Hong Kong	+8
BJS	Beijing	+8
TPE	Taipei	+8
SEL	Seoul	+9
TYO	Tokyo	+9
ADL	Adelaide	+9.5
GUM	Guam	+10
SYD	Sydney	+10
NOU	Noumea	+11
WLG	Wellington	+12

- * As of December 2012, the official UTC offset for Moscow, Russia (MOW) was changed from +3 to +4, but this watch still uses an offset of +3 (the old offset) for MOW. Because of this, you should leave the summer time setting turned on (which advances the time by one hour) for the MOW time.
- The rules governing global times (GMT differential and UTC offset) and summer time are determined by each individual country.